

QUICK START GUIDE

FOR ONCAM C-SERIES
INDOOR CAMERA
RJ45 AND PUNCH DOWN
OPTIONS

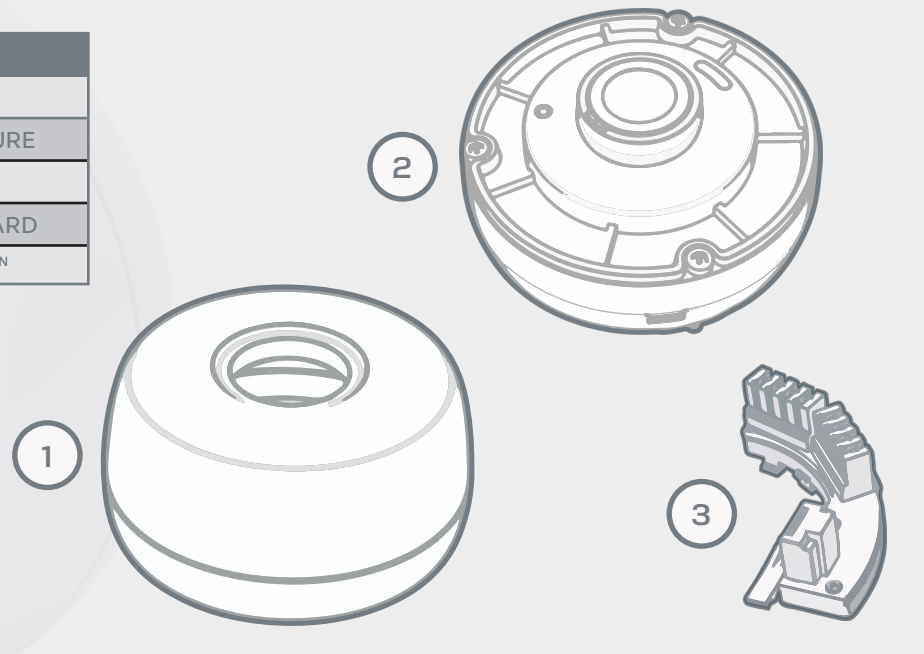

BOX CONTENTS	
Nº.	DESCRIPTION
1	CAMERA ENCLOSURE
2	CAMERA MODULE
3	PUNCHDOWN BOARD
4	HEX TOOL *NOT SHOWN



RJ45 INSTALLATION

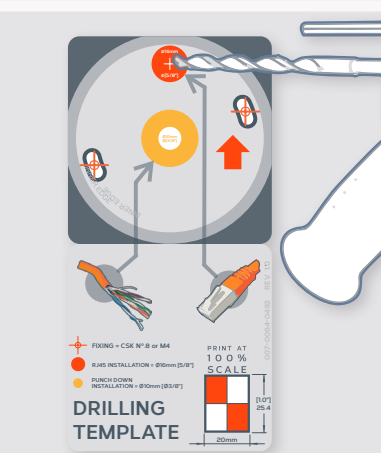

A REMOVE TEMPLATE AFTER DRILLING

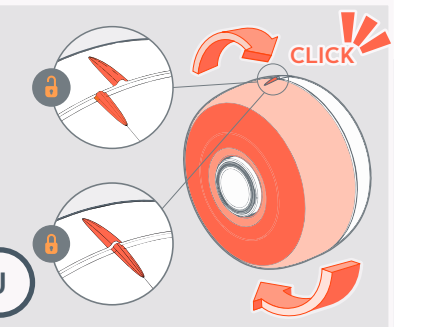
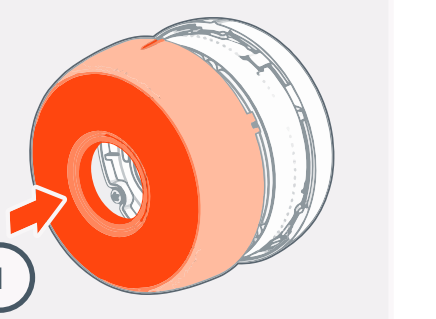
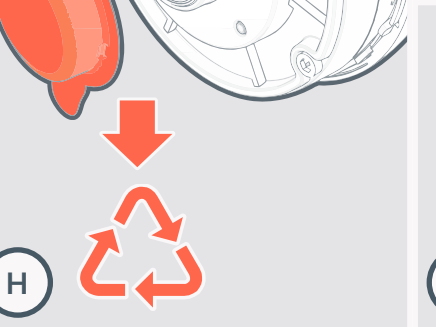
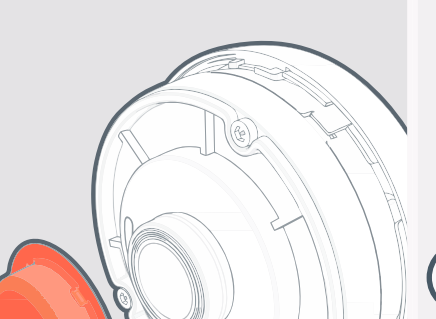
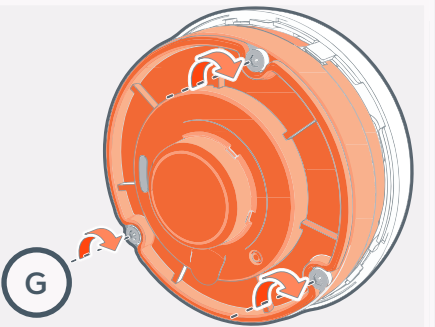
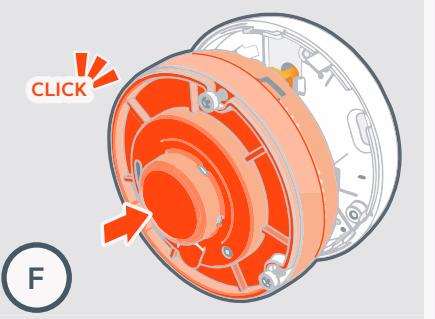
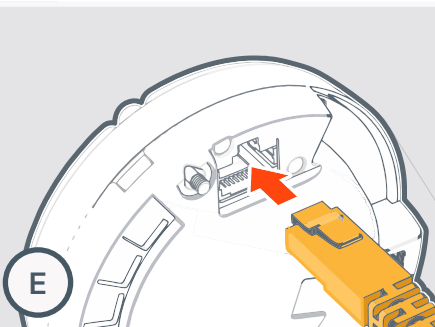
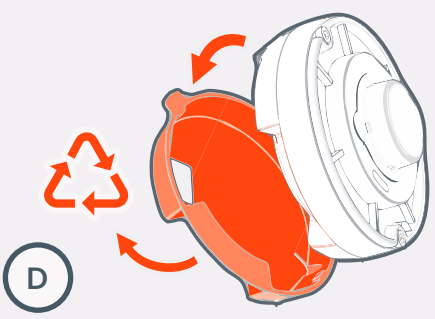
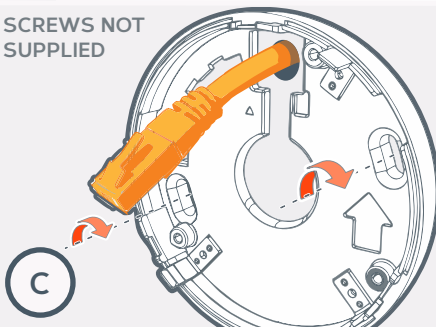
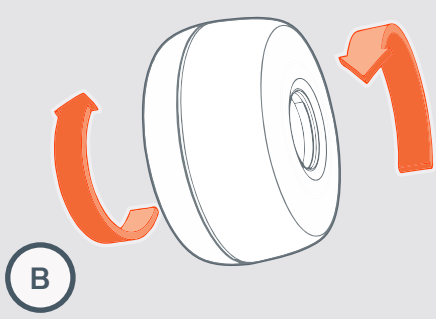

FOR MORE INFORMATION AND FIRST TIME SET UP GO TO:
[HTTPS://WWW.ONCAMGRANDEYE.COM/ONCAM-C-SERIES-INDOOR-SETUP](https://www.oncamgrandeeye.com/oncam-c-series-indoor-setup)

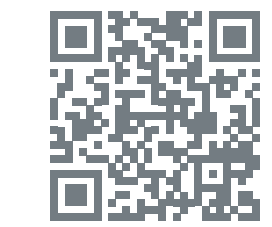

© COPYRIGHT 2020 ONVU TECHNOLOGIES AG. ALL RIGHTS RESERVED.
ONCAM IS A TRADING NAME OF ONVU TECHNOLOGIES AG.
SUBJECT TO CHANGE WITHOUT NOTICE.

REVISION 6.0

BOX CONTENTS

Nº	DESCRIPTION
1	CAMERA ENCLOSURE
2	CAMERA MODULE
3	PUNCHDOWN BOARD
4	HEX TOOL *NOT SHOWN

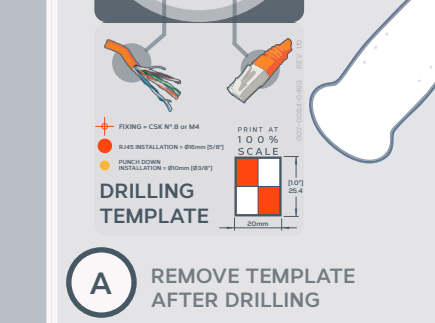
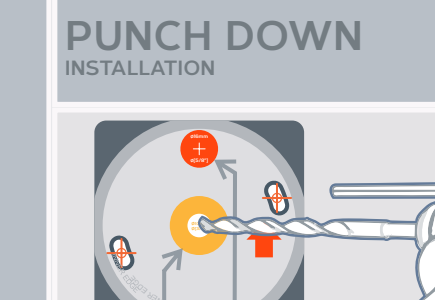
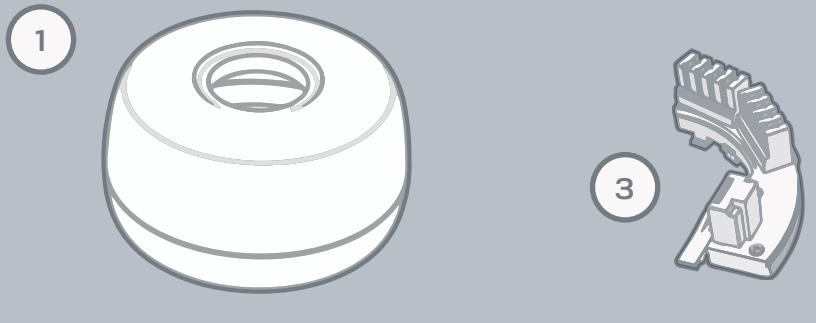

PUNCH DOWN INSTALLATION



A REMOVE TEMPLATE AFTER DRILLING

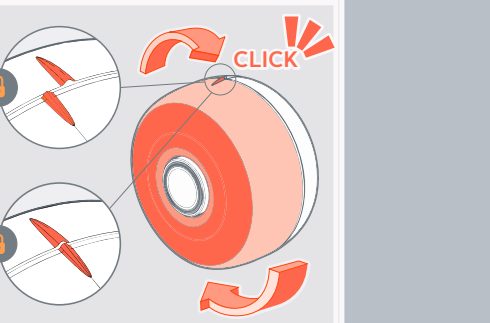
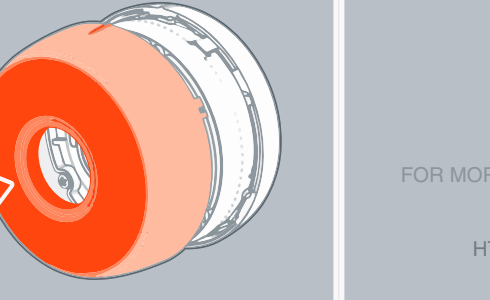
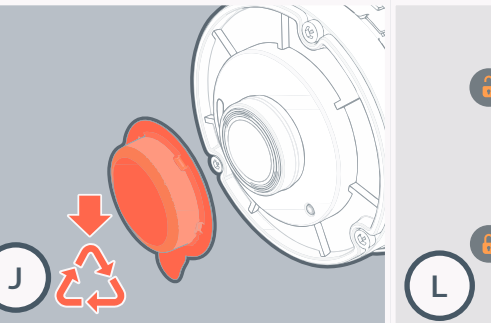
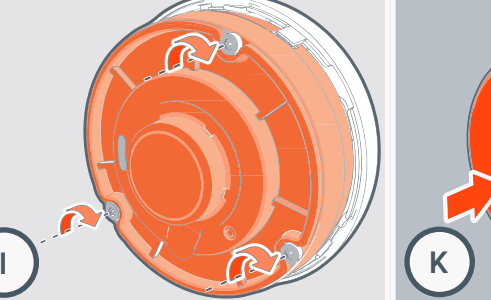
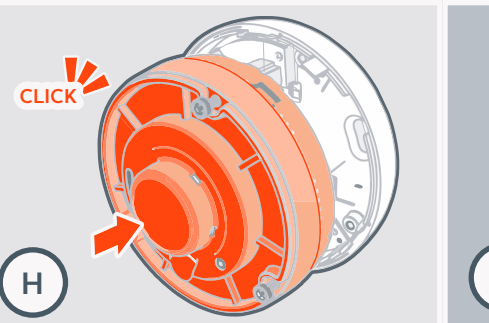
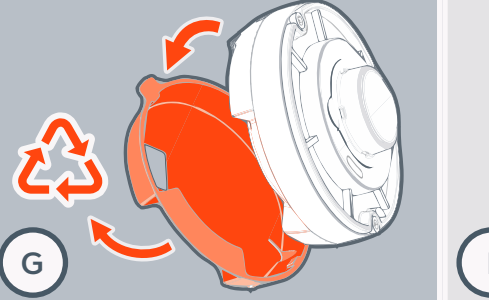
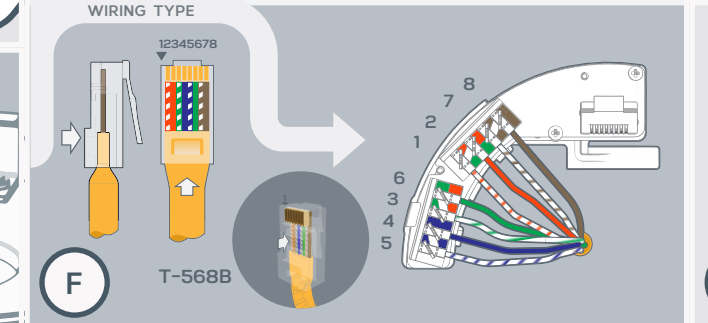
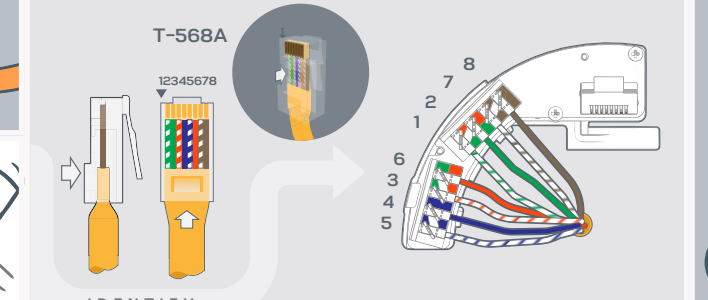
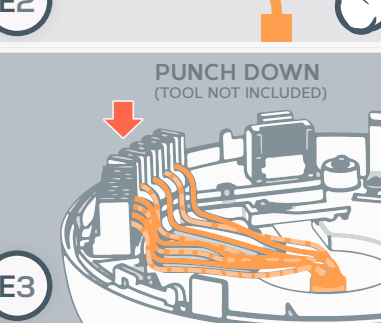
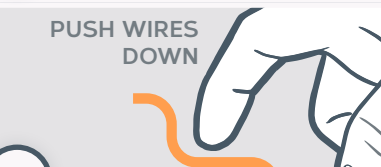
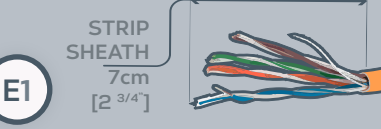
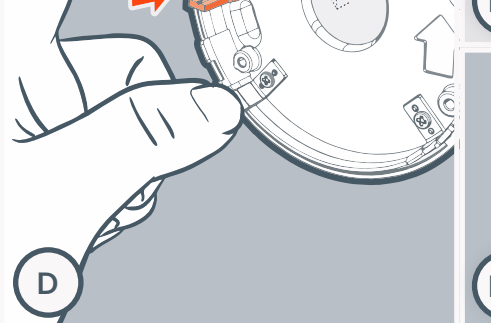
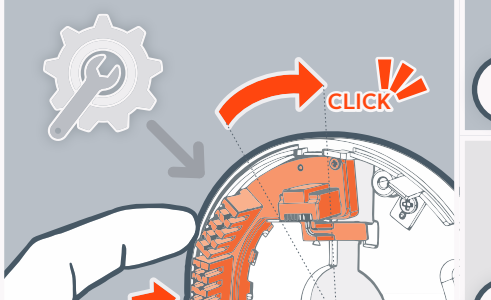
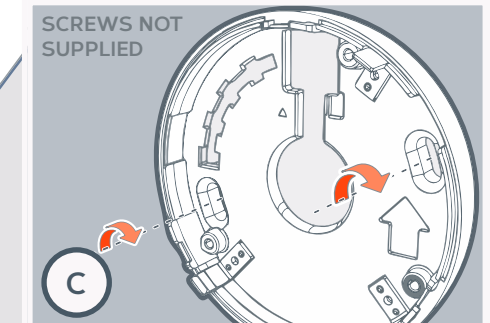
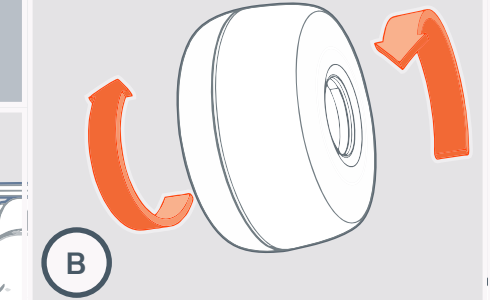

ONCAM

FOR MORE INFORMATION AND FIRST TIME SET UP GO TO:

[HTTPS://WWW.ONCAMGRANDEYE.COM/ONCAM-C-SERIES-INDOOR-SETUP](https://www.oncamgrandeeye.com/oncam-c-series-indoor-setup)